

CURVIA 4 SEAL

SHAPES

PENDANT - RECESSED - SURFACE



Declare.



Our extensive Curvia family illuminates with elegant curvilinear shapes and patterns, enhancing spaces with a soft touch and a graceful sense of movement. Curvia Seal luminaires are specifically engineered for applications that require varying levels of protection from dust and water and available at two Ingress Protection (IP) levels: IP54 and IP65.

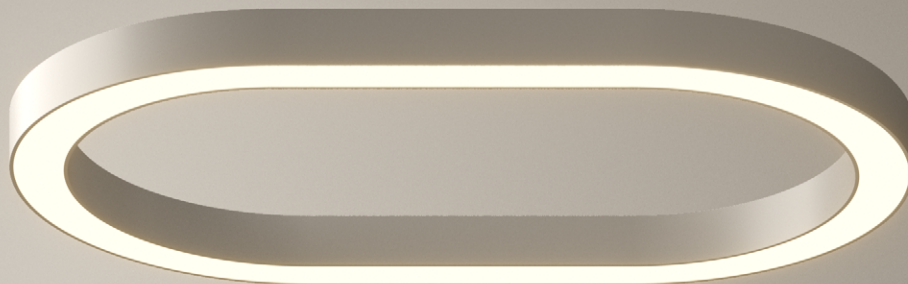
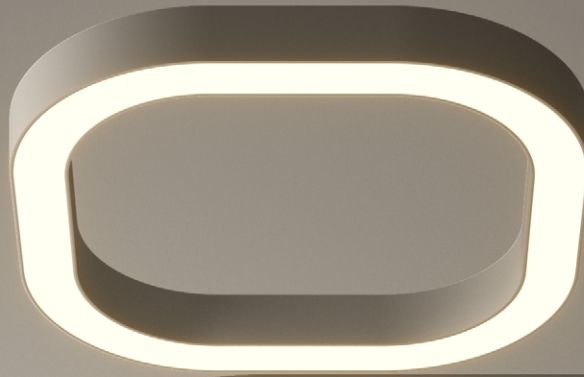

SENSORS
For latest information on sensors, click [here](#).



Curvia Additions Brochure

Curvia Family (Refer to other spec sheets)

Curvia Mini	Curvia Slim	Curvia Slim Seal	Curvia Prism	Curvia	Curvia XYZ	Curvia Horizon	Curvia Perimeter	Curvia Seal Perimeter	Curvia Seal	Curvia Acoustix
1"	1", 2"	1", 2"	2"	2", 3", 4"	2", 3"	2", 3"	2", 3", 4", 5"	2", 3", 4"	2", 3", 4"	2"
Ring	Ring Shapes Pattern	Ring Shapes Pattern	Ring Shapes Pattern	Ring Shapes Pattern	Pattern	Ring Shapes	Pattern	Pattern	Ring Shapes Pattern	Ring Shapes Pattern

3737 Cote Vertu St-Laurent, Quebec, Canada H4R 2C9
T (514) 225-4304 F (514) 931-4862
www.lumenwerx.com



Lumenwerx reserves the right to modify product specifications without notification.
© Lumenwerx, ULC. All rights reserved.
CURVIA4-SEAL-SHAPES-SPEC-REV1 May 5, 2026

CURVIA 4 SEAL

SHAPES

PENDANT - RECESSED - SURFACE



IMPORTANT:
Fixture must be installed with lens facing down.

Project: _____

Type: _____

Order Guide

LUMINAIRE ID	DISTRIBUTION	ENVIRONMENT ¹	SIZE ²	CORNER RADIUS ⁵ Specify NA for capsule	OPTIC
	D				EPDO

<p>SQUARE CURV4SEALSQP - Curvia 4" Seal Square Pendant CURV4SEALSQR - Curvia 4" Seal Square Recessed CURV4SEALSQS - Curvia 4" Seal Square Surface</p> <p>RECTANGLE CURV4SEALREP - Curvia 4" Seal Rectangle Pendant CURV4SEALRER - Curvia 4" Seal Rectangle Recessed CURV4SEALRES - Curvia 4" Seal Rectangle Surface</p> <p>CAPSULE CURV4SEALCAP - Curvia 4" Seal Capsule Pendant CURV4SEALCAR - Curvia 4" Seal Capsule Recessed CURV4SEALCAS - Curvia 4" Seal Capsule Surface</p>	<p>D - Direct</p>	<p>IP65 - IP65-Rated IP54 - IP54-Rated</p> <p>¹See page 4 for more information on the features and installation details for each environment option.</p>	<p>#FT#IN#FT#IN ^{3,4} - Nominal length X nominal width</p> <p>²The real dimension of the fixture can differ up to 2.5" from the nominal size.</p> <p>³Specify nominal length (#) and width (#) in 1" and/or 1" increments.</p> <p>⁴Minimum size: Square 4" x 4", Rectangle 4" x 6", and Capsule 3" x 2".</p>	<p>R12 - 12" radius R18 - 18" radius R24 - 24" radius R30 - 30" radius R36 - 36" radius RXX ⁶ - Custom radius in inches NA ⁷ - Not applicable</p> <p>⁵Radii are referenced to fixture centerline. ⁶Minimum radius is 8". Consult factory for smaller radii. ⁷For capsule, radius is defined by the size.</p>	<p>EPDO - Environmentally Protected Direct Optic</p>
--	--------------------------	--	---	--	---

LIGHT SOURCE ⁸	CRI	LUMEN PACKAGE ⁹	COLOR TEMPERATURE	VOLTAGE

<p>SW - Static white FS - Full spectrum static white</p> <p>⁸Chromawerx SOLA, DUO, and QUADRO also available. Consult factory.</p>	<p><u>Static white</u> 80CRI - 80+ CRI 90CRI - 90+ CRI</p> <p><u>Full spectrum</u> 95CRI - 95+ CRI</p>	<p>350LMF - Eco low output 350 lm/ft 500LMF - Low output 500 lm/ft 750LMF - Medium output 750 lm/ft 1000LMF ¹⁰ - High output 1000 lm/ft 1200LMF ¹⁰ - Ultra high output 1200 lm/ft</p> <p>⁹To calculate the total lumens, multiply the lumen package (lm/ft) by the length of the shape (ft). ¹⁰Not available with full spectrum.</p>	<p>27K - 2700K 30K - 3000K 35K - 3500K 40K - 4000K 50K - 5000K</p>	<p>120V - 120V 277V - 277V UNV - 120V-277V 347V ¹¹ - 347V</p> <p>¹¹Available with D1 driver only. Subject to factory evaluation.</p>
--	--	--	---	---

DRIVER ¹²	ELECTRICAL	ELECTRICAL SECTIONS (optional) ^{21, 22}

<p>D1 - 1% 0-10V ELV ^{13, 14} - ELV 120V TRI ^{13, 14} - TRIAC 120V DA ¹⁵ - DALI LDE1 ^{14, 15} - Lutron Hi-Lume 1% Eco ELD1 - eldoLED 1% ECOdrive 0-10V ELDO - eldoLED 0.1% SOLOdrive 0-10V RLTD10 ¹⁶ - Low-temperature 10% 0-10V</p> <p>¹²Integral or remote subject to factory evaluation. Code will be updated with prefix "R" if factory determines driver to be remote. ¹³Available with 120V only. ¹⁴Not suitable for temperatures below 0°C (32°F). ¹⁵On-site commissioning is required. ¹⁶Driver is remote. A remote driver box is provided. Suitable for temperatures down to -40°C/F.</p>	<p>1C - 1 circuit #MC ¹⁷ - Multi circuit EC - Emergency-powered fixture NL - Night light fixture DL - Daylight fixture GTD ^{18, 19, 20} - Generator transfer device fixture</p> <p>¹⁷Specify total number of circuits (#), including any required for electrical section options. Provide drawing or layout specifications. Minimum 4' section per circuit for integral drivers. ¹⁸Integral or remote subject to factory evaluation. GTD must be housed with the driver. ¹⁹Not available with 347V. ²⁰Not suitable for environments below 0°C (32°F).</p>	<p>#EC## ²³ - Emergency-powered section #NL## ²³ - Night light section #DL## ²³ - Daylight section</p> <p>#GTD## ^{23, 24, 25, 26} - Generator transfer device section #EMB ^{24, 25, 26, 27, 28} - Emergency battery NA - None</p> <p>²¹Specify with multi circuit (#MC) electrical option only. ²²Provide drawing or layout specifications. Consult factory for other configurations. Default section length is 4'. ²³Specify quantity (#), and section length in inches (##). ²⁴Integral or remote subject to factory evaluation. GTD/EMB must be housed with the driver. ²⁵Not available with 347V. ²⁶Not suitable for environments below 0°C (32°F). ²⁷Specify quantity (#). Each battery powers a 4' linear section. Minimum length of linear section is 5'. ²⁸All batteries will be on the same circuit.</p>
---	---	---

POWER FEED	MOUNTING ³⁰	FINISH	OPTION

<p>TF - Top feed EF ²⁹ - End feed</p> <p>²⁹Not available with pendant mounting options.</p>	<p>PENDANT ³¹</p> <p>SSTS - Stem, standard SSTC() - Stem, custom</p> <p>³⁰The mounting option selected must reflect the luminaire ID. ³¹Standard canopies are black for black fixtures, and white for all other finishes. See page 3 for full details on standard and custom options.</p>	<p>RECESSED</p> <p>DTR - Trim DMF - Drywall mud flange</p>	<p>SURFACE</p> <p>GSM - Gasketed surface mount</p>	<p>W - Matte white AL - Aluminum B - Matte black WA - White antimicrobial Silverwerx CF# - Custom finish, specify RAL#</p>	<p>CRF - Corrosion-resistant finish NA - None</p>
--	---	--	--	---	--



CURVIA 4 SEAL

SHAPES

PENDANT - RECESSED - SURFACE



Pendant Mounting Code

Stem

Standard

SSTS - Stem, standard

- Ø 5" for power canopy
- Ø 5" for non-power canopy
- Canopies are black for black fixtures, and white for all other fixture finishes
- Power cord is black for black fixtures, and white for all other fixture finishes
- Stem finish is the same color as fixture
- Stem length is 18"
- Stem is not field adjustable

Custom

Example: SSTC(5NPC-36IN-W-STW-PCW-SLS)

SSTC() - Stem, custom

NON-POWER CANOPY SIZE	STEM LENGTH	CANOPY FINISH	STEM COLOR	POWER CORD COLOR	OPTION
5NPC - Ø 5" non-power canopy	18IN - 18" 36IN - 36" #IN ² - Specify length in inches ² Minimum length is 6". Maximum length is 72". Stem is not field adjustable.	W - Matte white AL - Aluminum B - Matte black CF# - Custom finish, specify RAL#	STW - Matte white STAL - Aluminum STB - Matte black STCF# - Custom finish, specify RAL#	PCW - White PCB - Black	SLS - Sloped ceiling for stem NA - None

Dimensions

PENDANT

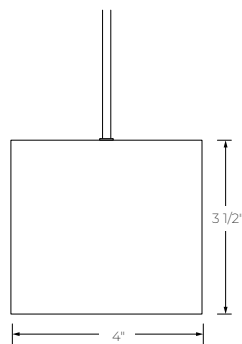

DIRECT

RECESSED

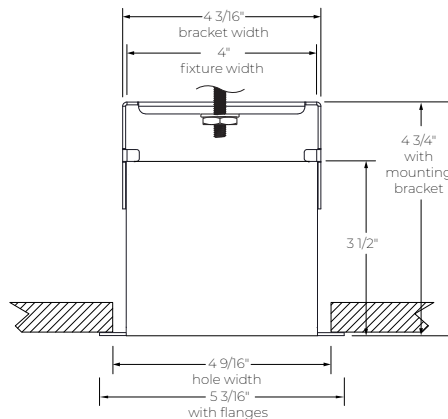

DTR - Trim

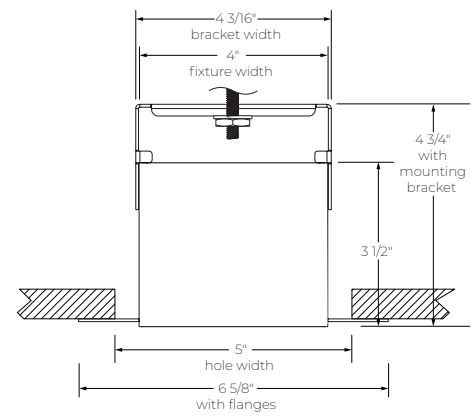

DMF - Drywall mud flange

SURFACE

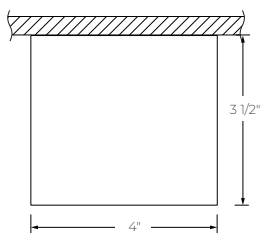

GSM - Gasketed surface mount

CURVIA 4 SEAL

SHAPES

PENDANT - RECESSED - SURFACE



Environment Options

DIRECT

IP65-RATED



Fixture is dust-tight and sealed against water jets from any direction.

Wet listed

Low-profile joiner bridge every 8'

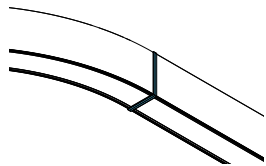

Direct

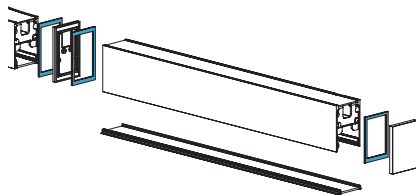

OUTDOOR: Exposed to the elements

Suitable for ambient temperatures of -20°C (-4°F) to 30°C (86°F) **

INDOOR: Wet Listed applications, healthcare applications, high-maintenance settings

IP54-RATED

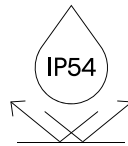

Fixture is dust and water-splash protected with reinforced sealed protection for internal electrical components*. The lens, joiners and end caps are gasketed for secure sealing.

Wet listed

Gasketed joiner

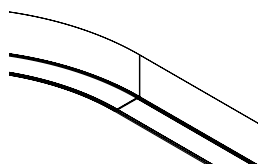

Direct

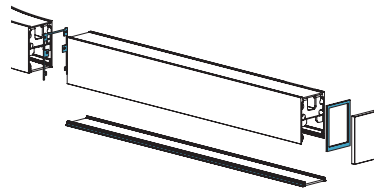

OUTDOOR: Mild exposure to the elements, under canopy

Suitable for ambient temperatures of -20°C (-4°F) to 30°C (86°F)**

INDOOR: Wipe-down environments

* Internal electrical components are IP65-rated. The driver is fully enclosed, wiring connections are sealed to prevent ingress of dust and moisture, and the LED board is conformal-coated for enhanced protection.

** Some restrictions apply.

CURVIA 4 SEAL

SHAPES

PENDANT - RECESSED - SURFACE



Shapes

SQUARE SHAPE

RADIUS: 12", 18", 24", 30", 36"

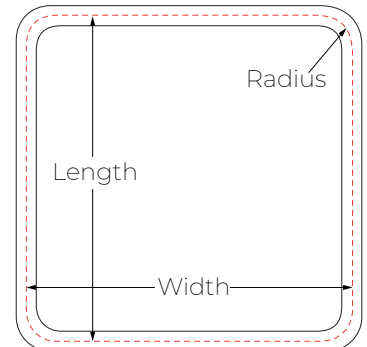
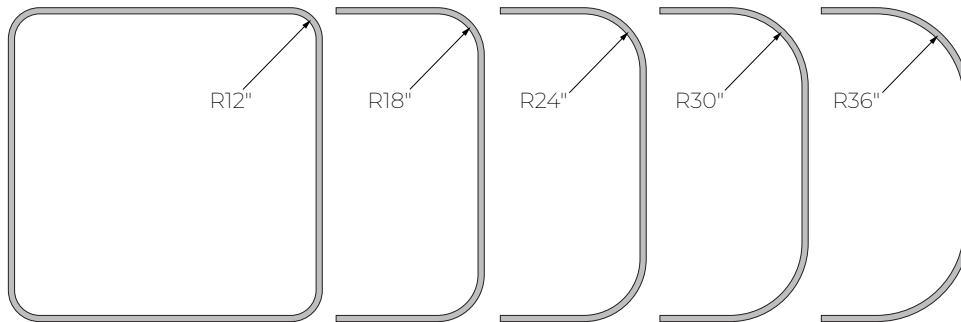

Note: The length, width and radius are measured from the center of the fixture.

RECTANGLE SHAPE

RADIUS: 12", 18", 24", 30", 36"

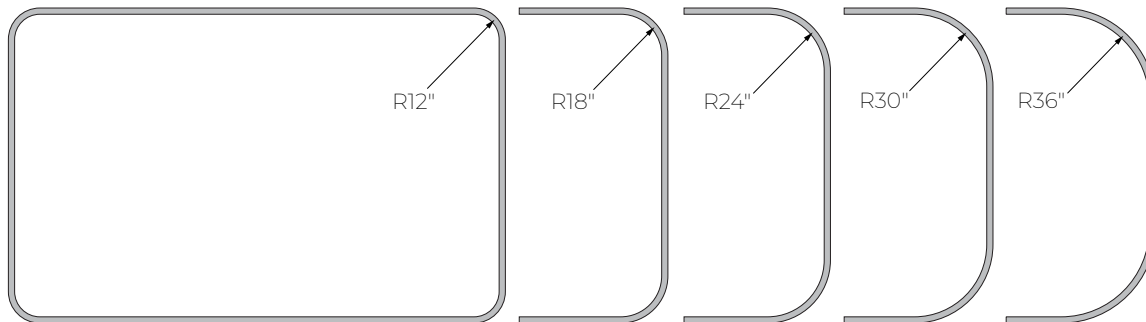

CAPSULE SHAPE

WIDTH: 24", 36", 48", 60", 72"

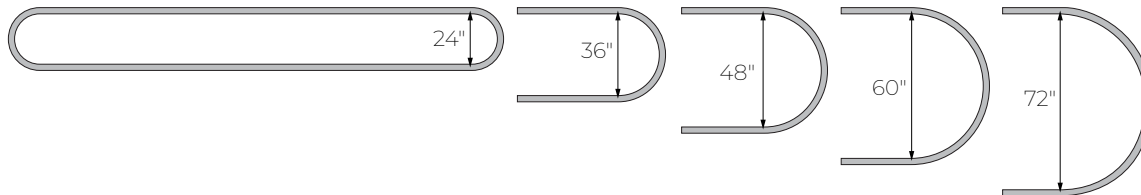

Configuration diagrams are not to scale. For visualization purposes only.

CURVIA 4 SEAL

SHAPES

PENDANT - RECESSED - SURFACE



Photometrics

Values calculated based on 4' straight segments at 3500K.

DIRECT OPTIC

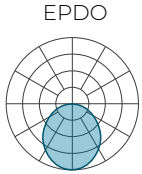

LM/FT	W/FT	LM/W
350	2.7	132
500	3.9	129
750	6	126
1000	8.2	122
1200	10	119

MULTIPLIER TABLE

Use this table to get results for different color temperatures.

CCT	WATTS		LPW
	80+ CRI / 90+ CRI	80+ CRI / 90+ CRI	80+ CRI / 90+ CRI
2700K	1.05		0.95
3000K	1.02		0.98
3500K	1.00		1.00
4000K	1.00		1.00
5000K	0.96		1.04

CURVIA 4 SEAL

SHAPES

PENDANT - RECESSED - SURFACE



Technical Specifications

OPTIC

Environmentally Protected Optic (EPDO)

The Environmentally Protected Optic features an innovative sealed design with our exclusive Supreme Grip™ Technology and advanced gasketing, ensuring a precise, secure fit on the extrusion while delivering superior protection against dust, water, and UV distortion.

LIGHT SOURCE

Static white

Custom array of mid-flux LEDs are cartridge-mounted with quick-connect wiring to facilitate service and thermal management. Available in 2700K, 3000K, 3500K, 4000K, and 5000K with a minimum 80+ CRI and an option for 90+ CRI with elevated R9 value. Color consistency maintained to within 3 SDCM. LEDs operate at reduced drive current to optimize efficacy and lumen maintenance. All LEDs have been tested in accordance with IESNA LM-80-08 and the results have shown L80 lumen maintenance greater than 60,000 hours. Absolute product photometry is measured and presented in accordance with IESNA LM-79, unless otherwise indicated.

Full spectrum static white

The full spectrum LED option offers improved color particularly in the cyan region that is beneficial in both healthcare and circadian lighting strategies. The cyan region in full spectrum LED is richer at the 480 nm range.

ELECTRICAL

Factory-set, adjustable output current LED driver with universal (120-277 VAC) input. Dimmable from 100% to 1% with 0-10V dimming control. Rated life (90% survivorship) of 50,000 hours at 50°C max. ambient (and 70°C max. case) temperature. At maximum driver load: Efficiency>84%, PF>0.9, THD<20%. Other specifiable options include Lutron Hi-Lume 1% Eco, eldoLED 1% ECOdrive 0-10V, eldoLED 0.1% SOLOdrive 0-10V, ELV, TRIAC, and DALI protocol drivers. All of our standard 0-10V drivers are NEMA 410 compliant. An optional low temperature 10% 0-10V driver, suitable for temperatures down to -40°C/F is also available. ELV and TRIAC dimming performance (including minimum dimming percentage) subject to dimmer selection.

PoE

Depending on the PoE manufacturer selected, Lumenwerx will install the node in factory as either integral to the luminaire or as a remote module. Factory programming of the PoE node may or may not enable the following functionalities: lumen package, DUO (tunable white), QUADRO (RGBW), emergency battery backup, and sensor integration. These must be addressed and evaluated on a case-by-case basis.

Battery

Factory installed long life, high temperature, maintenance-free Lithium-Ion battery pack with self-test functionality, test switch and charge indicator. Minimum of 90 minutes operation, up to 1000 lumens per 4' (25°C) emergency lighting output and recharge time of 24 hours.

Generator Transfer Device (GTD)

A UL924 listed shunt relay that can bypass both line voltage (120-277 VAC) and 0-10V dimming signal. Suited for ambient temperatures of 0°C (32°F) to 60°C (140°F).

MOUNTING

Pendant: Pendant fixtures can be mounted with stem.

Recessed: Recessed fixtures can be mounted in ceilings with trim or mud flange options.

Surface: Surface fixtures can be mounted directly to hard surface ceilings, hardware supplied by others. A minimum of 6" from the vertical wall is required.

FINISH

Interior: 95%, reflective matte powder coated white paint.

Exterior: Matte white, matte black or aluminum powder coating. Custom finishes are also available.

CONSTRUCTION

Housing: Extruded aluminum and aluminum sheet

Reflectors: Aluminum

Lens: Polycarbonate

Stem: Ø 1/2" threaded steel tube

WEIGHT

	Pendant	Recessed	Surface
IP65	2.75 lb/ft - 1.24 kg/ft	3.5 lb/ft - 1.59 kg/ft	2.75 lb/ft - 1.24 kg/ft
IP54	2.5 lb/ft - 1.13 kg/ft	3.2 lb/ft - 1.45 kg/ft	2.5 lb/ft - 1.13 kg/ft

CERTIFICATIONS

ETL: IP65-Rated and IP54-Rated environment options are ETL Wet Listed. Conforms to UL Standard 1598 and certified to CAN/CSA Standard C22.2 No. 250.0. During the installation of Wet Listed fixtures, the contractor is responsible for properly sealing all mounting and electrical connection points.

IC rated: Suitable for direct contact with insulation. For Recessed mounting only.

CURVIA 4 SEAL

SHAPES

PENDANT - RECESSED - SURFACE



WARRANTY

Lumenwerx provides a five-year limited warranty on electrical and mechanical performance of the luminaires, including the LED boards, drivers, and auxiliary electronics. Lumenwerx will repair or replace defective luminaires or components at our discretion, provided they have been installed and operated in accordance with our specifications. Other limitations apply, please refer to the full warranty on our website.